

IUH1-B シリーズ



単相乾式複巻変圧器 (Dry-type Insulation Transformer)

- 海外規格 (cULマーク、CEマーク) 対応のグローバル単相トランス
- 入力電圧が380~480Vで出力が100V系or200V系
- RoHS2対応品 (10物質対応2018年度中に完了予定 ※規制開始2019年7月22日)

適合規格 Standard
EN61558-1: 2019, EN61558-2-4: 2009
IEC61558-1: 2017, IEC61558-2-4: 2009
BS EN IEC 63000: 2018

UL 認定 UL Recognition
 UL ファイル No. E219074
 UL 5085-1, UL 5085-2
 CSA C22.2 No.66.1-06, No.66.2-06

絶縁種別 Class
H種

相数 Phase 単相 (1φ) 周波数 Frequency 50/60Hz

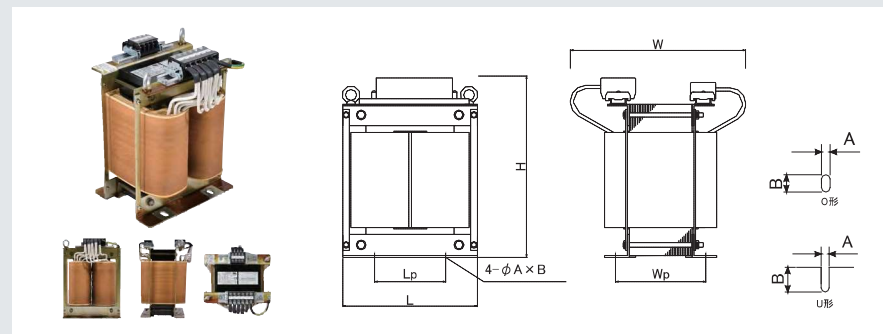

IUH1-B シリーズ オプション及び型式選定方法

型式: IUH1-B①S-② ①容量 ②電圧番号

電圧番号 Voltage No. 003

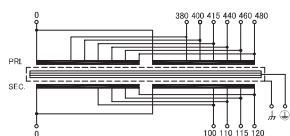

電圧番号 Voltage No. 273

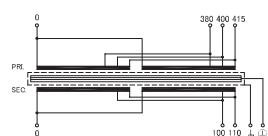

一次電圧 (V) Primary	380/400/415 440/460/480		380/400/415		容量 (kVA)	寸法 (mm)							保護素子		
	100/110/115/120		100/110			L	Lp	W	Wp	H	φA×B	質量 (kg)	取付穴	一次 (A)	二次 (A)
二次電圧 (V) Secondary															
電圧番号 Voltage No.	003		273												
型式 Model	IUH1-B4000S-003	IUH1-B4000S-273	4	240	130	270	145	335	11×20	42	O形	20	40		
	IUH1-B5000S-003	IUH1-B5000S-273	5	245	130	320	165	335	11×20	50	O形	20	50		
	IUH1-B7500S-003	IUH1-B7500S-273	7.5	305	180	320	165	385	13×20	70	O形	30	75		
	IUH1-B010S-003	IUH1-B010S-273	10	320	185	340	175	435	13×20	95	O形	40	100		

IUH1-B シリーズ 型式選定方法

型式: IUH1-B①S-② ①容量 ②電圧番号

電圧番号 Voltage No. 323

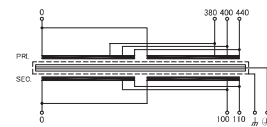

電圧番号 Voltage No. 373

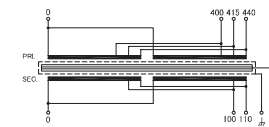

電圧番号 Voltage No. 473

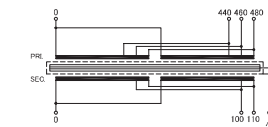

一次電圧 (V) Primary	380/400/440			400/415/440			440/460/480			容量 (kVA)	寸法 (mm)							保護素子	
	100/110			100/110			L	Lp	W		Wp	H	φA×B	質量 (kg)	取付穴	一次 (A)	二次 (A)		
二次電圧 (V) Secondary																			
電圧番号 Voltage No.	323			373			473												
型式 Model	IUH1-B4000S-323	IUH1-B4000S-373	IUH1-B4000S-473	4	240	130	270	145	335	11×20	42	O形	20	40					
	IUH1-B5000S-323	IUH1-B5000S-373	IUH1-B5000S-473	5	245	130	320	165	335	11×20	50	O形	20	50					
	IUH1-B7500S-323	IUH1-B7500S-373	IUH1-B7500S-473	7.5	305	180	320	165	385	13×20	70	O形	30	75					
	IUH1-B010S-323	IUH1-B010S-373	IUH1-B010S-473	10	320	185	340	175	435	13×20	95	O形	40	100					

電圧番号 Voltage No. 503

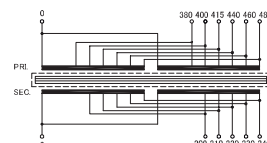

電圧番号 Voltage No. 773

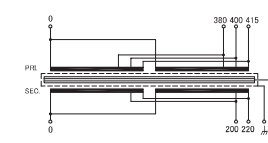

一次電圧 (V) Primary	380/400/415 440/460/480		380/400/415		容量 (kVA)	寸法 (mm)							保護素子	
	200/210/220/230/240		200/220			L	Lp	W	Wp	H	φA×B	質量 (kg)	取付穴	一次 (A)
二次電圧 (V) Secondary														
電圧番号 Voltage No.	503		773											
型式 Model	IUH1-B4000S-503	IUH1-B4000S-773	4	240	130	270	145	335	11×20	42	O形	20	20	
	IUH1-B5000S-503	IUH1-B5000S-773	5	245	130	320	165	335	11×20	50	O形	20	30	
	IUH1-B7500S-503	IUH1-B7500S-773	7.5	305	180	320	165	385	13×20	70	O形	30	40	
	IUH1-B010S-503	IUH1-B010S-773	10	320	185	340	175	435	13×20	95	O形	40	50	

電圧番号 Voltage No. 823

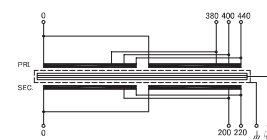

電圧番号 Voltage No. 873

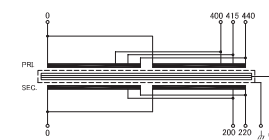

電圧番号 Voltage No. 973

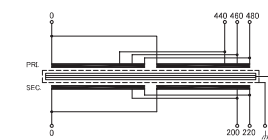

一次電圧 (V) Primary	380/400/440			400/415/440			440/460/480			容量 (kVA)	寸法 (mm)							保護素子	
	200/220			200/220			L	Lp	W		Wp	H	φA×B	質量 (kg)	取付穴	一次 (A)	二次 (A)		
二次電圧 (V) Secondary																			
電圧番号 Voltage No.	823			873			973												
型式 Model	IUH1-B4000S-823	IUH1-B4000S-873	IUH1-B4000S-973	4	240	130	270	145	335	11×20	42	O形	20	20					
	IUH1-B5000S-823	IUH1-B5000S-873	IUH1-B5000S-973	5	245	130	320	165	335	11×20	50	O形	20	30					
	IUH1-B7500S-823	IUH1-B7500S-873	IUH1-B7500S-973	7.5	305	180	320	165	385	13×20	70	O形	30	40					
	IUH1-B010S-823	IUH1-B010S-873	IUH1-B010S-973	10	320	185	340	175	435	13×20	95	O形	40	50					